

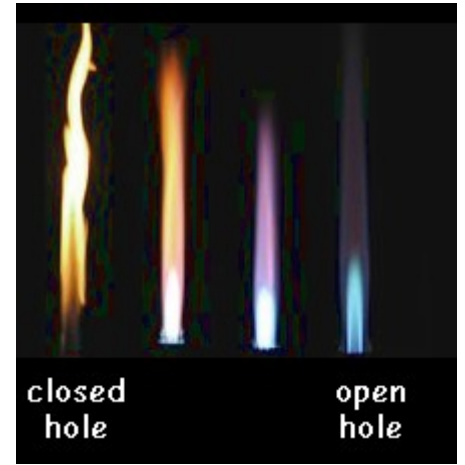

2W2524 [RM] © www.visualphotos.com

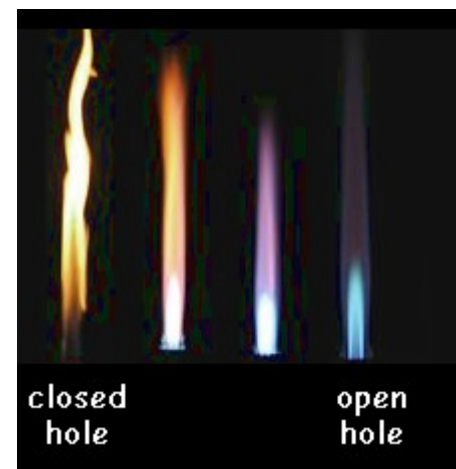

$$E = hc / \lambda$$

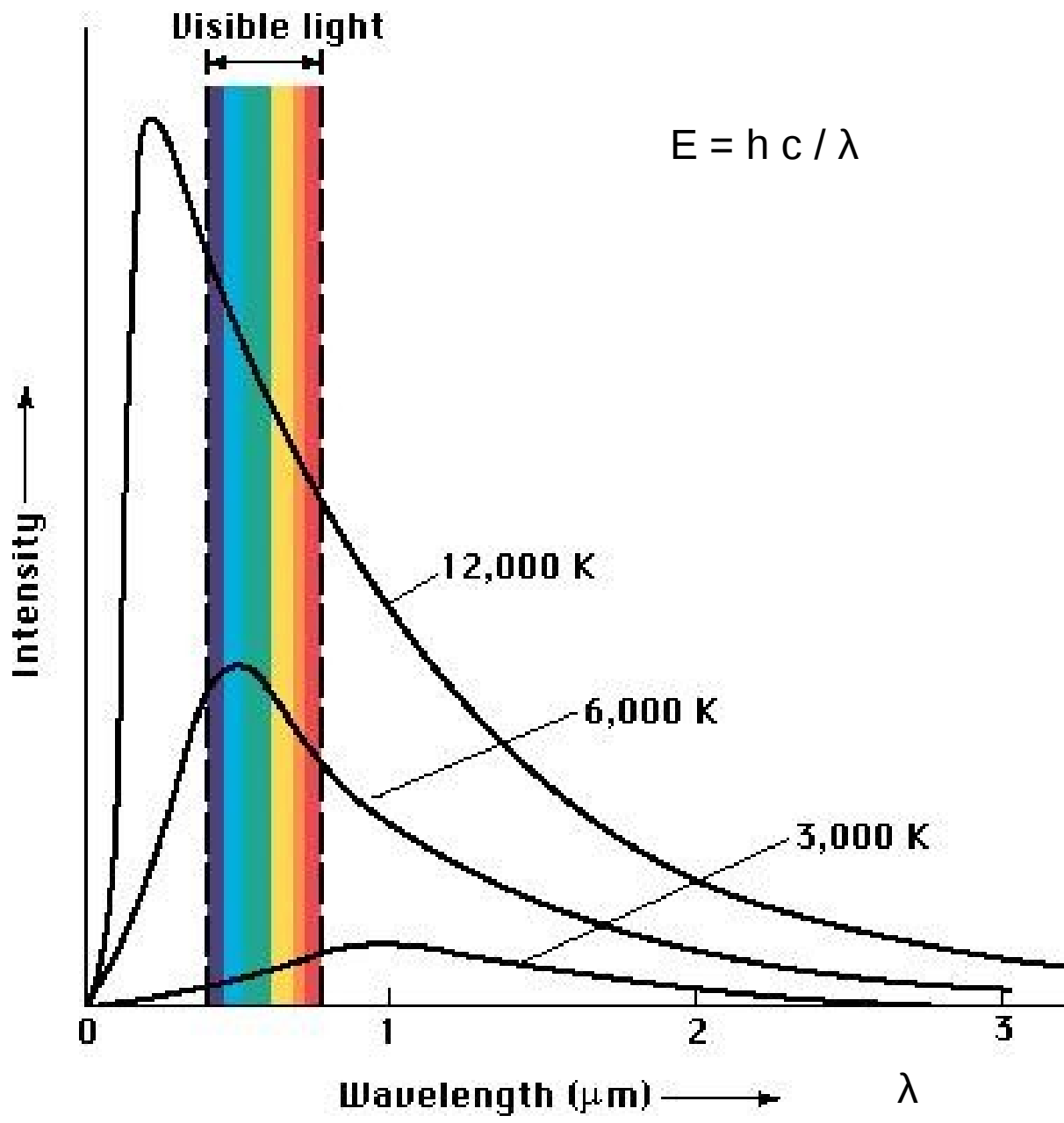

Espectro de Emissão do Sol

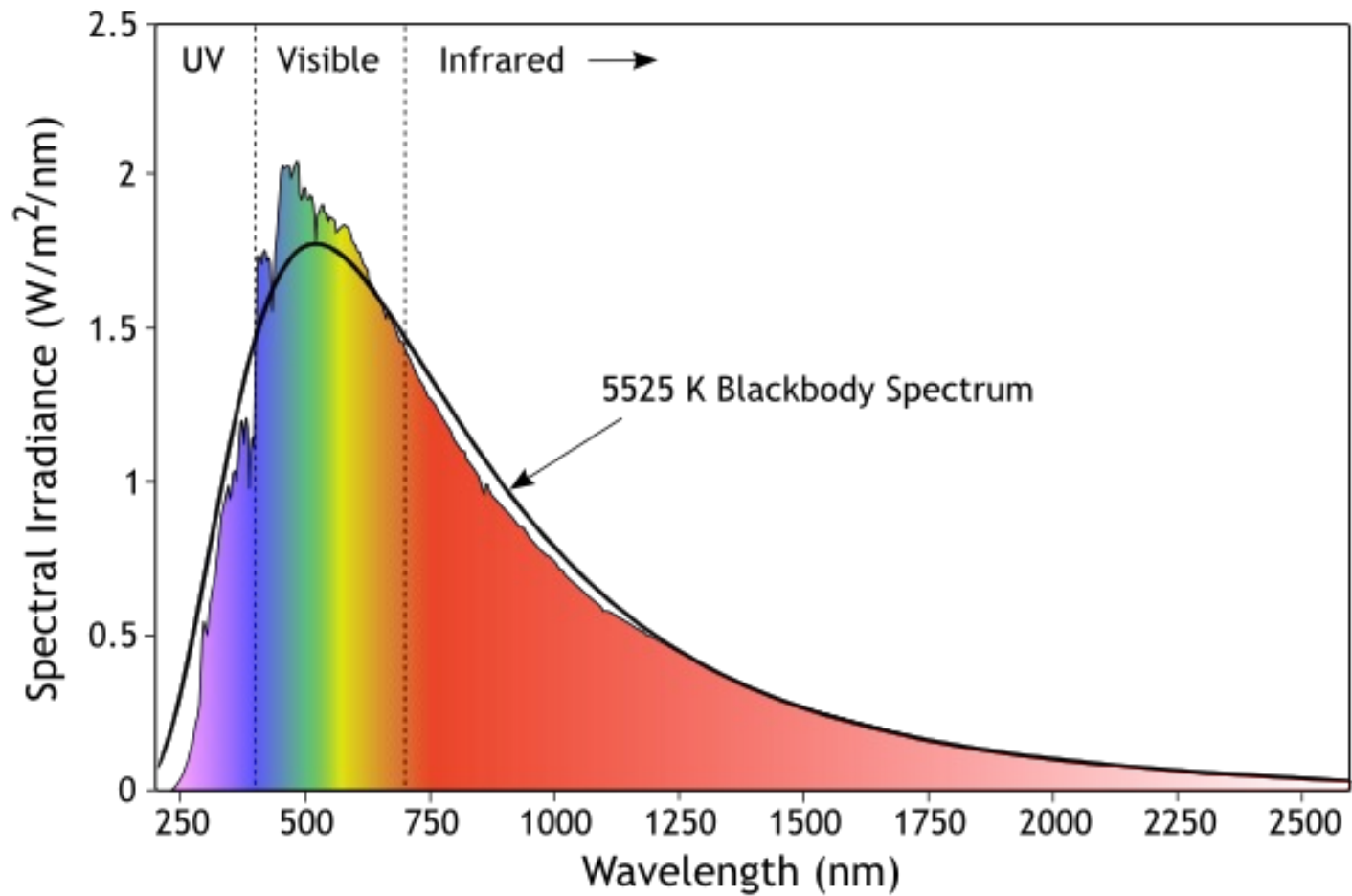

Espectro de Emissão do Sol

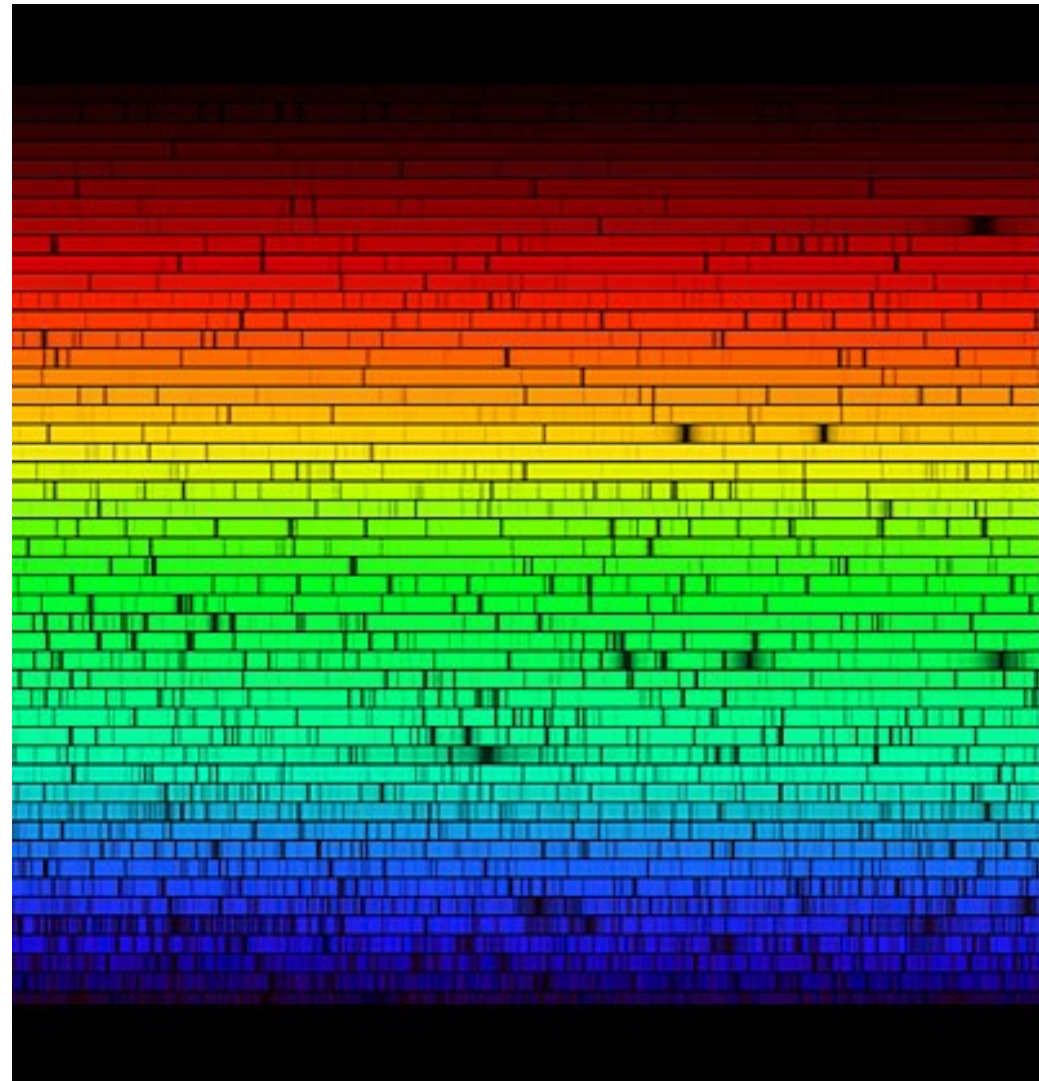
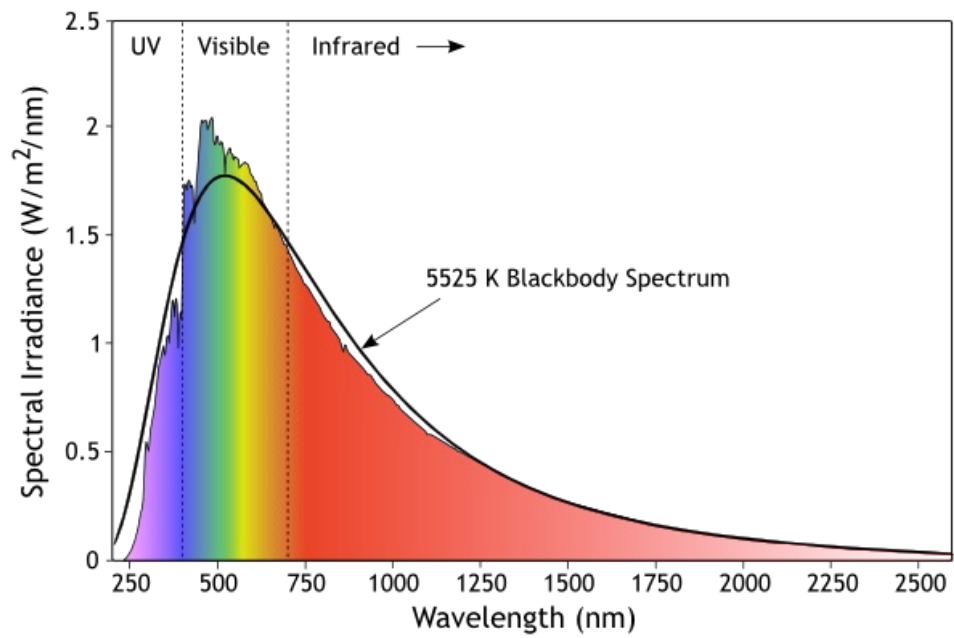

Íon de sódio: Na^+

Configuração eletrônica: $1s^2 2s^2 2p^6$

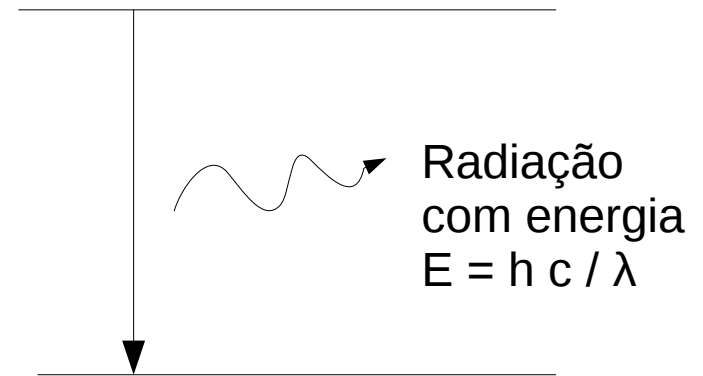
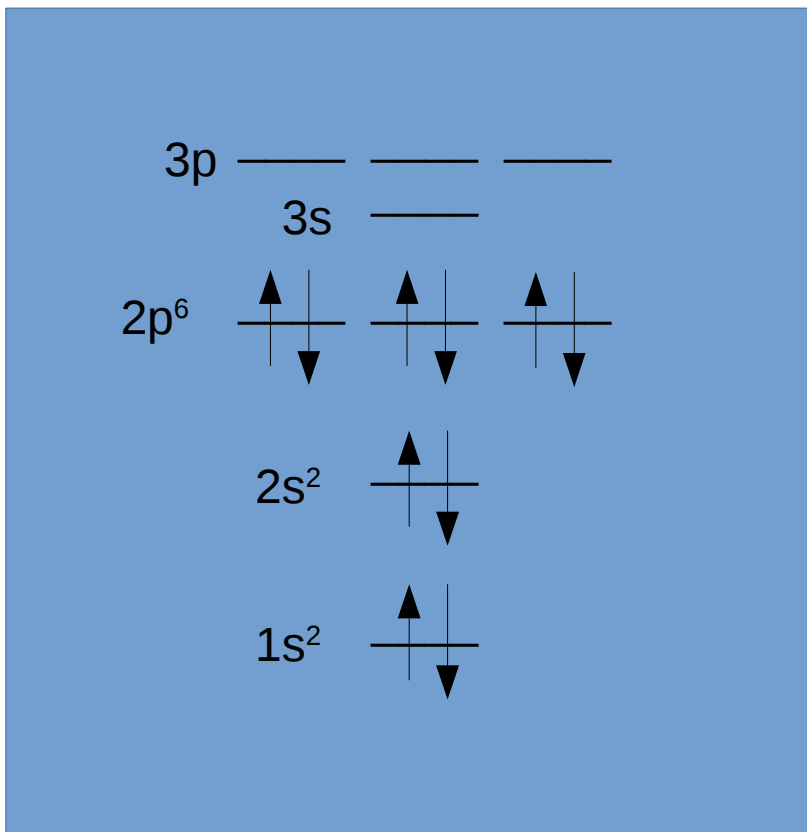

Íon de sódio: Na^+

Configuração eletrônica: $1s^2 2s^2 2p^6$

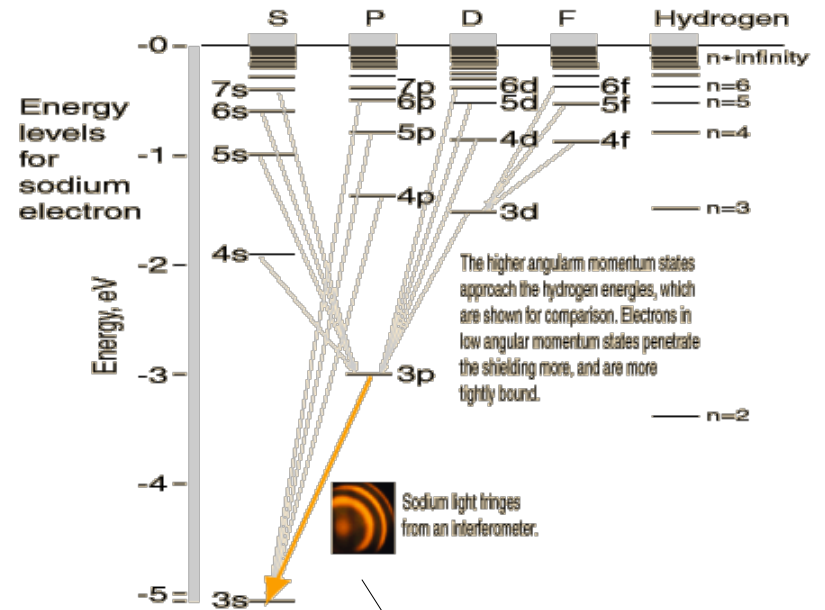
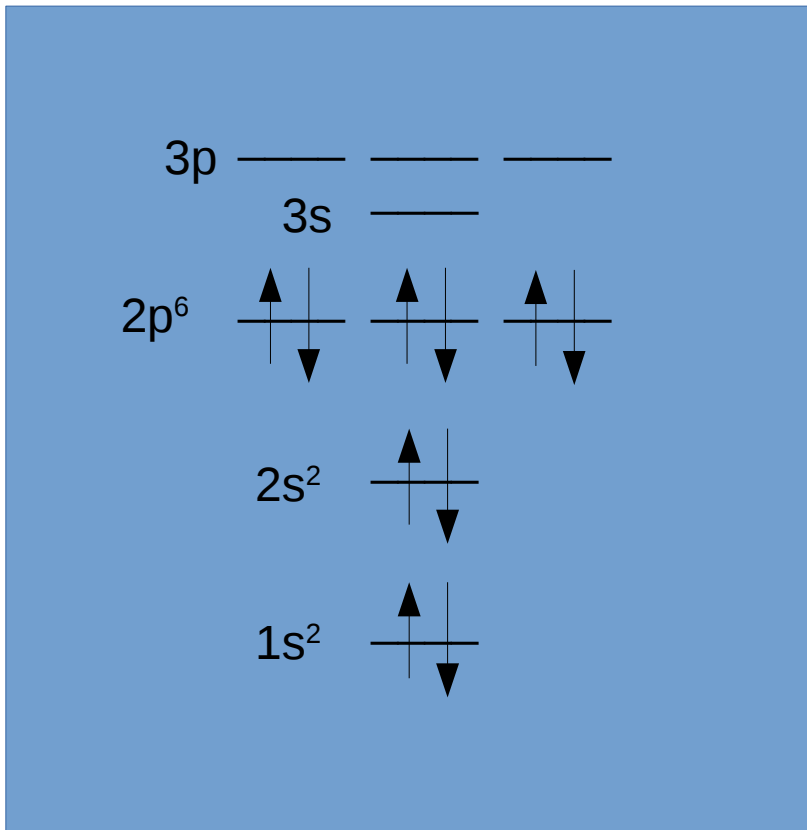

A intensa cor amarela está associada às transições transição $3p \rightarrow 3s$

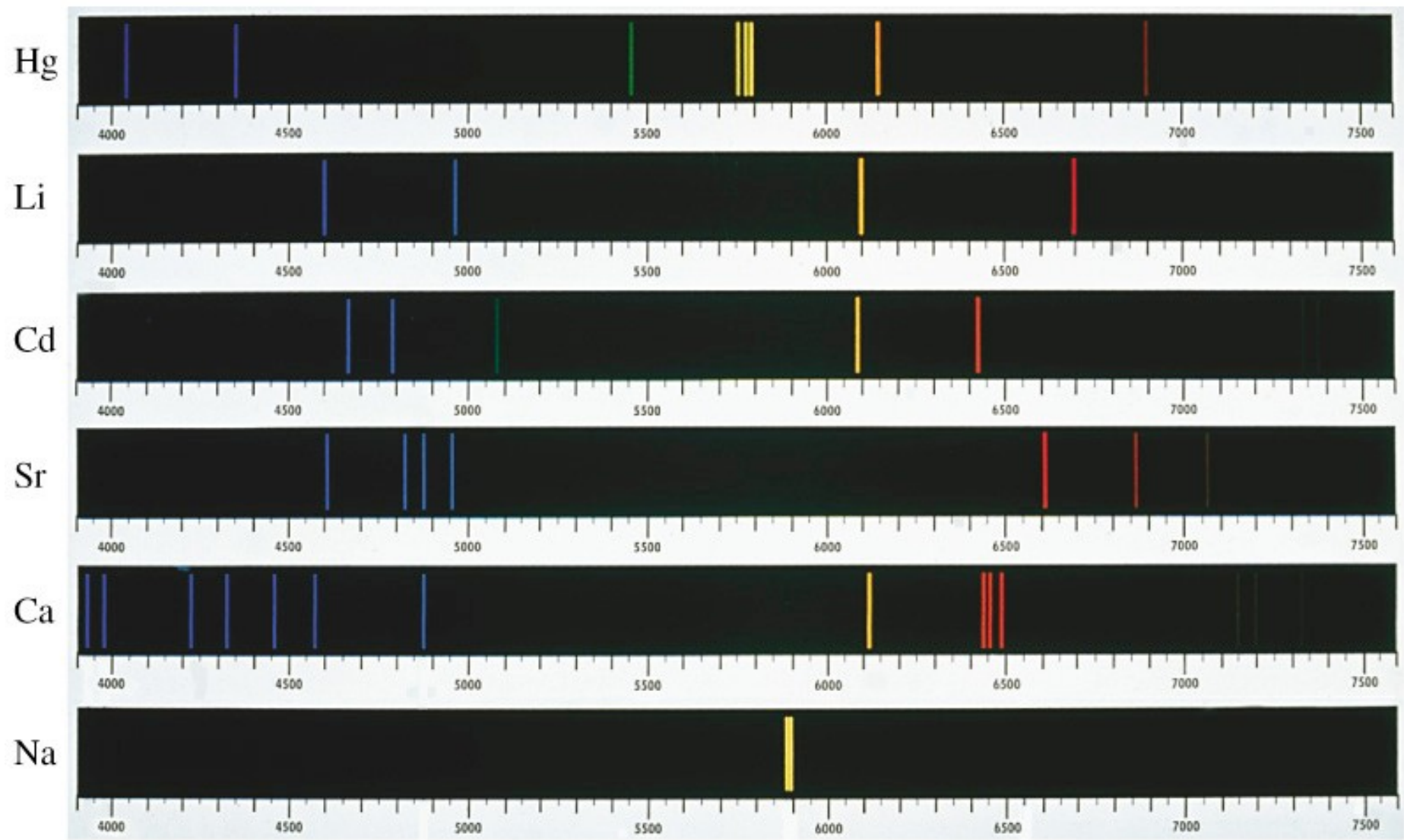

Emission Spectra of the Elements

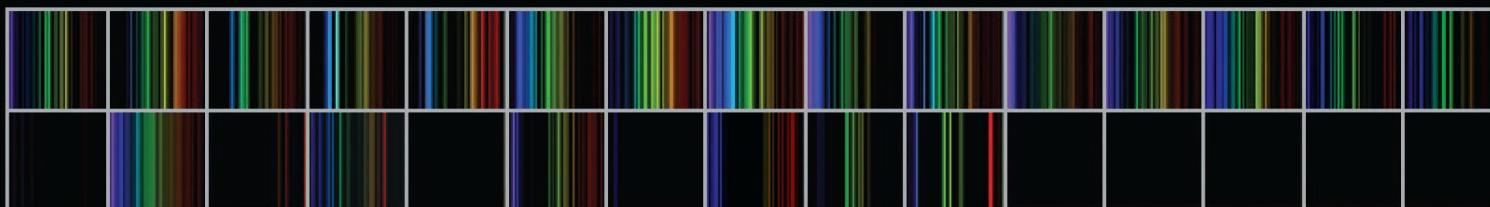
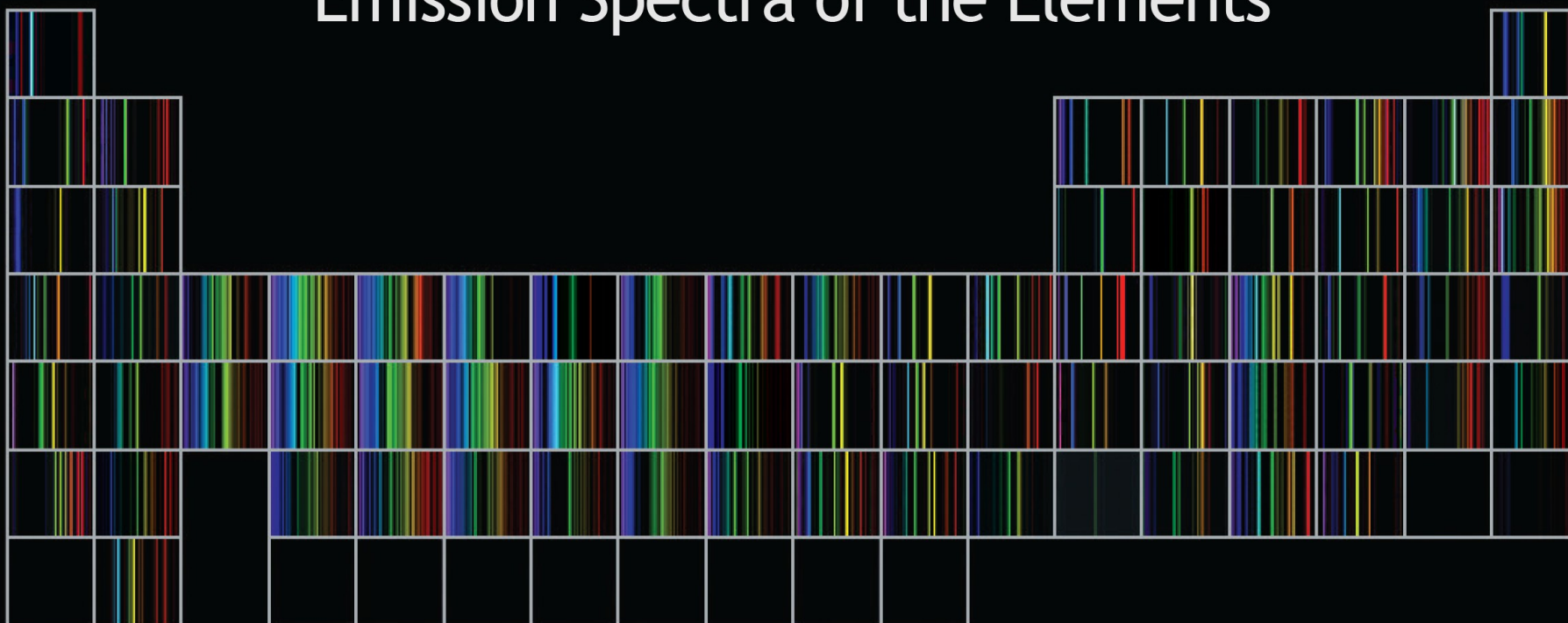

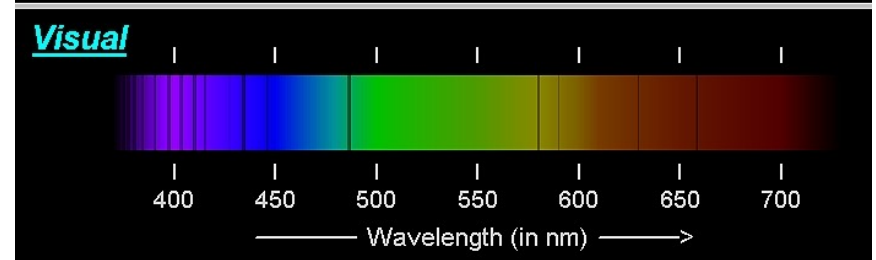
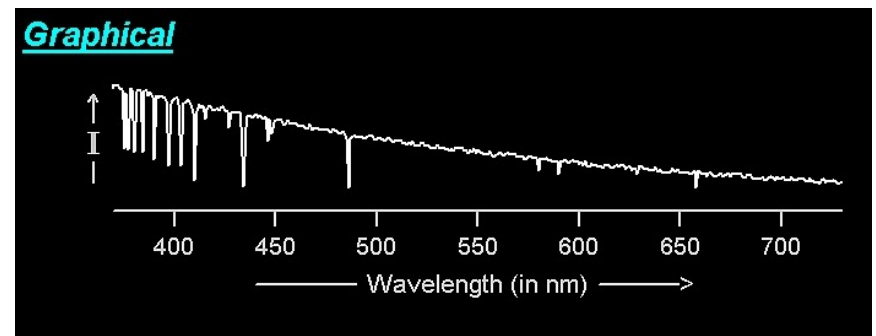
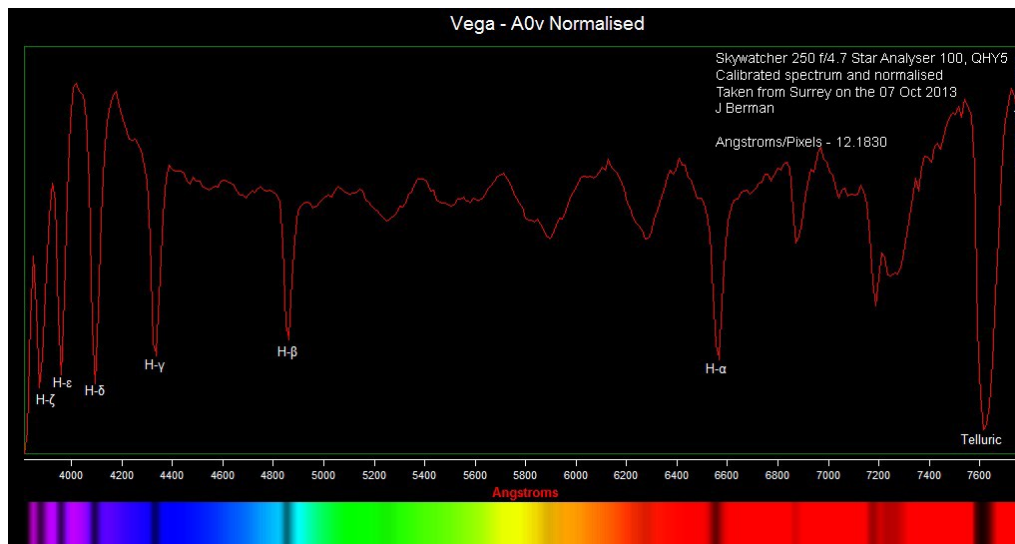
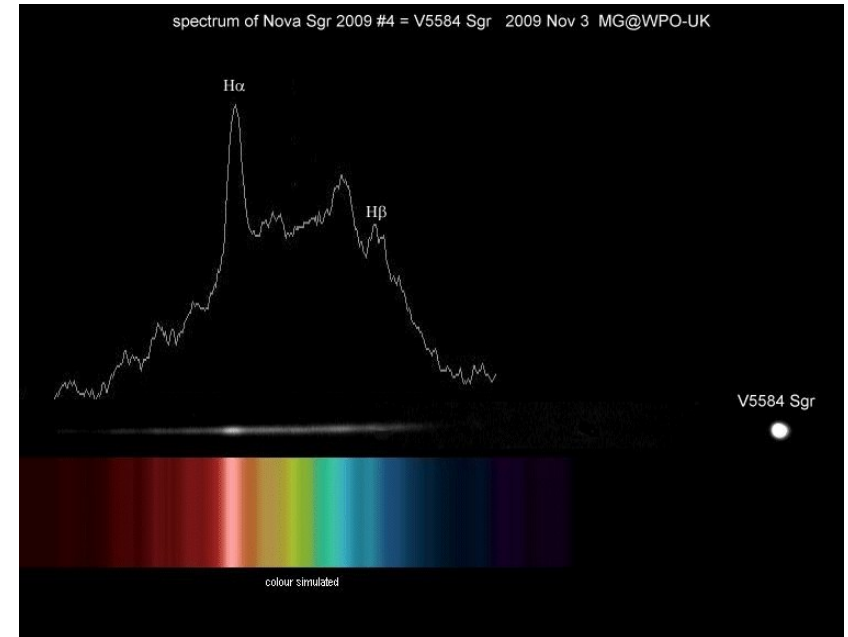

Espectrometria de absorção ou emissão atômica:



Figura 5. Curva analítica para cálcio, obtida usando o fotômetro de chama. Cada ponto é a média de cinco determinações. Neste intervalo de concentração obteve-se uma relação linear representada pela Equação 3, do texto



© Can Stock Photo

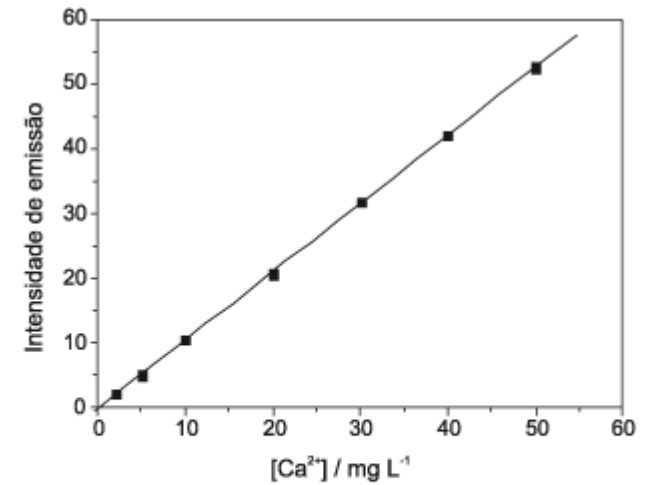
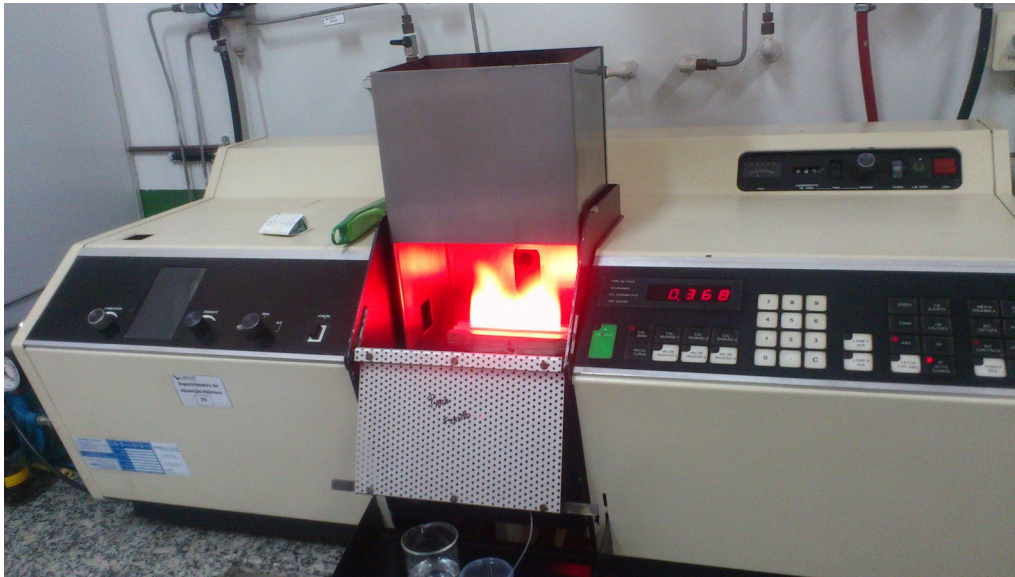
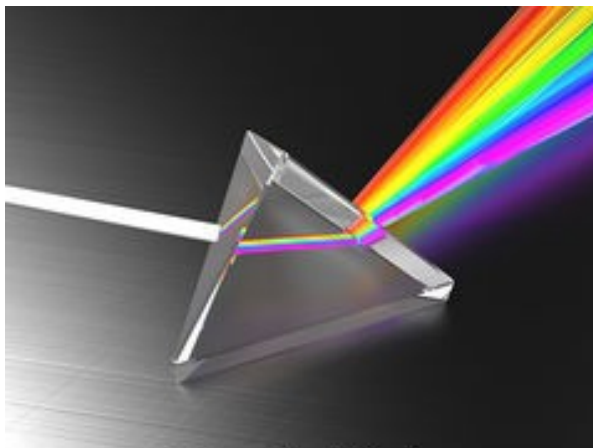

Bico de Bunsen

